



# HAS04

## 126 BROADBAND

Wavefront sensor  
**The Hulk**

From UV to IR  
Large pupil  
Alignment-free



 compatible



# HASO4 126 BROADBAND +

**The HASO4 126 BROADBAND Shack-Hartmann wavefront sensor provides high-resolution combined with a large pupil and large band for unmatched precision and versatility.**

This generation features the new SpotTracker™ technology. It provides absolute wavefront and tilt information, eliminating alignment requirements for faster and easier implementation.



Compatible with the **Optical Engineer Companion** modular system: easily combine the accessories you need.

## APPLICATIONS

Successfully used in the most demanding applications in optical metrology, microscopy, and laser diagnostics, the HASO4 126 BROADBAND performs multiple functions:

- + Quantify the aberrations of optical systems
- + Align the system to ensure that it performs at its best
- + Predict the optical system's performance in terms of focusing capability (PSF) or imaging quality (MTF)
- + Quantify the effects of temperature and gravity on system performance
- + Verify that the optics comply with specifications
- + Directly measure the optical system's wavelength dependency
- + Pilot a wavefront corrector to change the system's aberrations
- + Check whether the optical mount overly distorts the optics

## FEATURES

- + Easy wavefront measurement on the whole spectrum of the sensor: 350 - 1100 nm with no wavelength dependency
- + Easy setup on any beam size thanks to the large 13.8 x 10.2 mm<sup>2</sup> pupil
- + Direct wavefront acquisition of converging and diverging F/5 beams with an accuracy of  $\lambda/100$  RMS, including astigmatism and high-order aberrations
- + Beam collimation with an accuracy better than 300 m radius of curvature
- + Control and adjustment of axial laser beam deviation better than 3  $\mu$ rad RMS



# SPECIFICATIONS\*

## OPERATING SPECS

Aperture dimension	13.8 x 10.2 mm <sup>2</sup>
Number of microlenses	170 x 126
Maximum acquisition frequency	30 Hz (USB 3.0) or 8 Hz (GigE)
Calibrated wavelength range	350 - 1100 nm
Minimum power	0.15 nW
External trigger	TTL signal
Operating system	Windows 10

## OPTICAL SPECS

Repeatability	< $\lambda/200$ RMS
Absolute wavefront measurement accuracy	
• $\lambda$ between 350-600 nm	$\leq 6$ nm RMS
• $\lambda$ between 600-1100 nm	$\sim \lambda/100$ RMS
Spatial sampling	$\sim 80 \mu\text{m}$
Tilt dynamic range	$> \pm 3^\circ$
Focus dynamic range	$\pm 0.010$ m to $\pm \infty$

## MISC

Dimensions (Height x Width x Length)	42 x 47 x 60 mm <sup>3</sup> (USB 3.0)
Weight for USB version	185 g
Working temperature	15 - 30 °C
Interface	USB 3.0 or GigE
Power consumption	3.6 W

**HASO4**  
**126 BROADBAND**  
Wavelength range (nm)

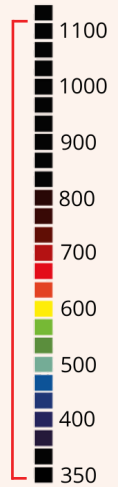

## HASO4 126 BROADBAND

Dynamic range at  $\lambda = 635$  nm

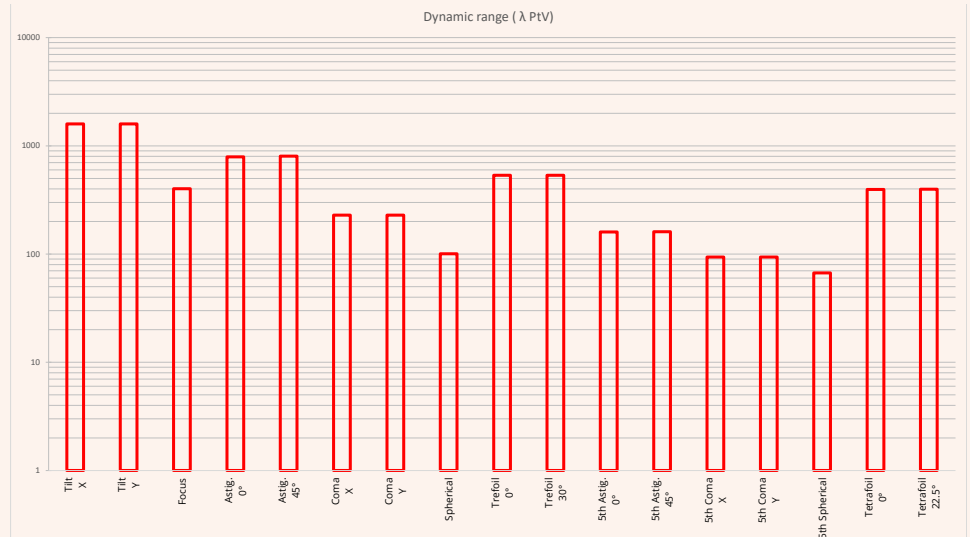

\*Subject to changes without further notice

## DIMENSIONS\*\* (mm)

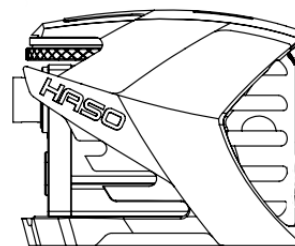
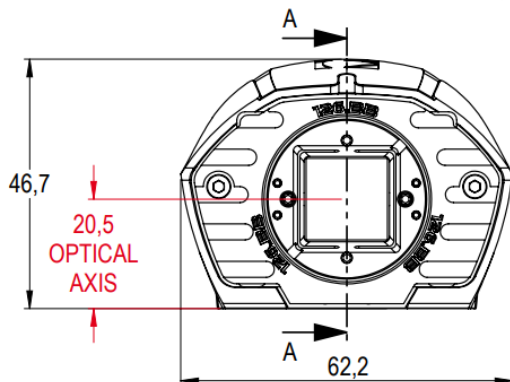

\*\*USB 3.0 model

# SOFTWARE

## WAVEVIEW™ Metrology Software

WAVEVIEW™ is the most advanced wavefront measurement and analysis software.

It offers more than 150 features and tools optimized for a wide range of highly demanding applications.

### Options :

- + Extensions for PSF, MTF and Strehl ratio
- + Optional SDK in C/C++, LabVIEW and Python

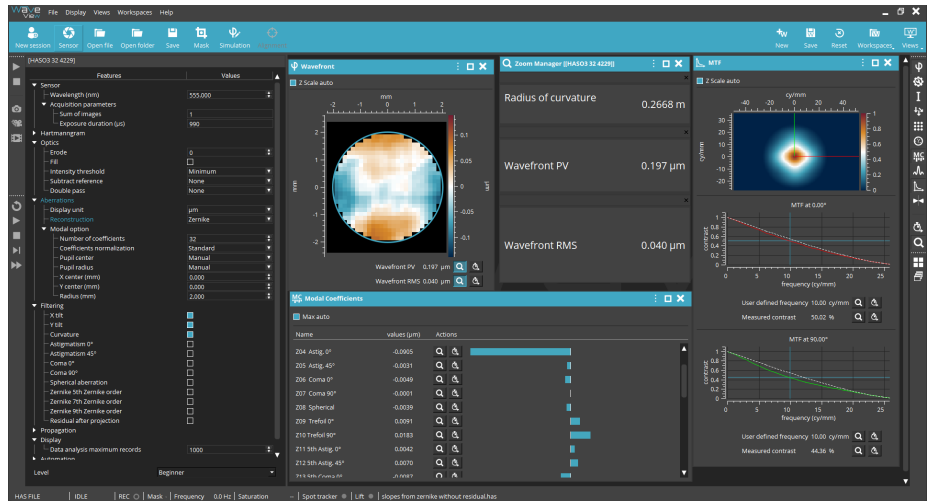

## WAVETUNE™ Adaptive Optics Software

WAVETUNE™ is a unique software that seamlessly combines wavefront measurement and correction features with extensive instrument diagnostics.

It is perfectly adapted to our HASO wavefront sensors, ILAO STAR, MIRAO and mu-DM deformable mirrors, as well as to a wide range of active components.

### Options :

- + Optional SDK in C/C++, LabVIEW and Python

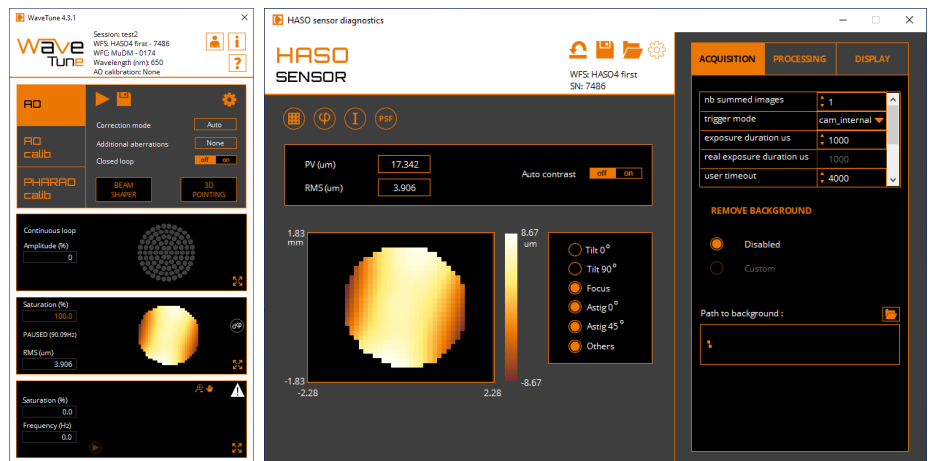

## CONTACT US

**Imagine Optic Headquarters**  
 18, rue Charles de Gaulle  
 91400 ORSAY · France  
 Phone +33 (0)1 64 86 15 60  
 sales@imagine-optic.com  
 www.imagine-optic.com

