

HASO

wavefront sensors
& optical metrology systems

imaginé
optic

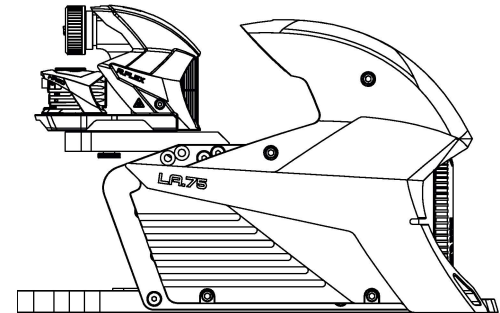
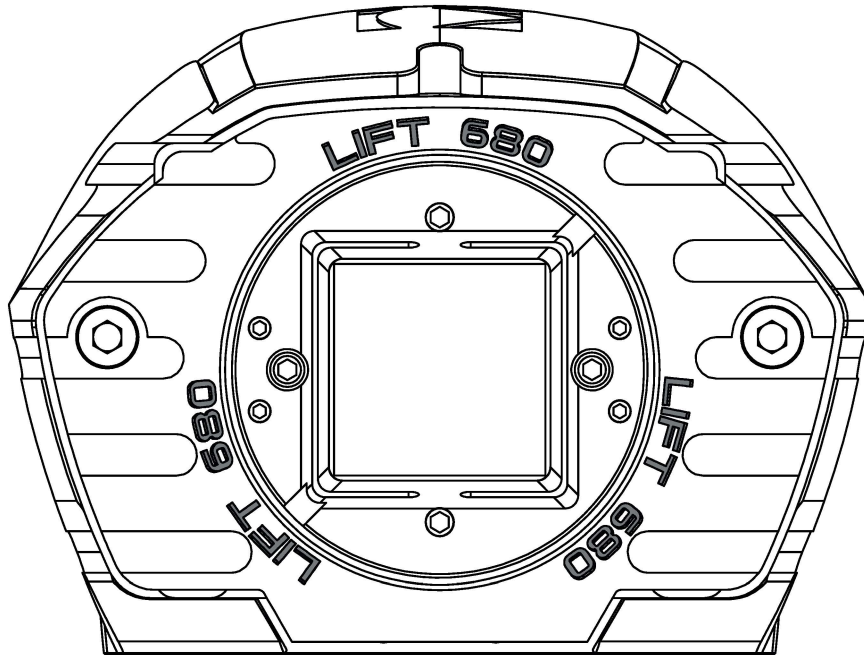

A 25-YEAR RUN IN WAVEFRONT SENSING AND OPTICAL METROLOGY

IN THIS BROCHURE

Click [on images](#) and titles to access product pages on our website.

Click on any page number to come back to this page.

WAVEFRONT SENSORS

- + HASO LIFT series
- + HASO4 series

OPTICAL METROLOGY SYSTEMS

- + R-FLEX LA platforms
- + R-FLEX2 systems
- + Optical Engineer Companion
- + Special WFS & optical benches

Imagine Optic's first generation of Schack-Hartmann wavefront sensors was designed and manufactured in Orsay 25 years ago.

Updates and iterations were developed beginning in the early 2000s, leading to the second, third and then the current fourth generations of HASO, covering an ever-broader range of applications for optical metrology and adaptive optics.

In 2020 the **HASO LIFT** series added super-resolution, bringing HASO wavefront sensing on par with Fizeau interferometers for most applications.

Today, the **Optical Engineer Companion** connects all the devices of the HASO wavefront sensing family of metrology tools, offering over 800 possible setups and unlimited possibilities.

2021

Optical Engineer Companion



1997

PH-Line profilometer



WAVESUITE 4.3, THE MOST INNOVATIVE SOFTWARE SUITE IN OPTICS

WaveSuite 4.3 is a landmark for metrology and adaptive optics software, featuring 3 components :

- + Waveview 4.3, the bench mark in wavefront metrology,
- + Wavetune 4.3, for perfect loop control in adaptive optics applications,
- + Wavekit 4.3, a versatile and comprehensive SDK in C LabVIEW and Python.

SpotTracker: alignment, done !

The SpotTracker feature in Waveview 4.3 was developed to simplify alignment. It instantly displays the absolute tilt of any incoming wavefront, making alignment as trivial as it is precise.

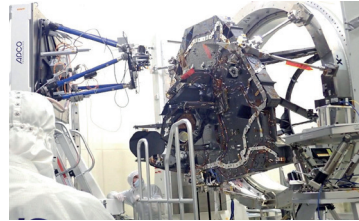

Alignment of the EUCLID telescope
With two R-FLEX optical metrology systems.
(Courtesy of Airbus Defense and Space)

Shack-Hartmann wavefront sensors use a microlens array and a CCD or CMOS camera to measure the wavefront local slopes and compute the aberrations of the beam. Their reliability makes Shack-Hartmann the most trusted reference in wavefront sensing applications.

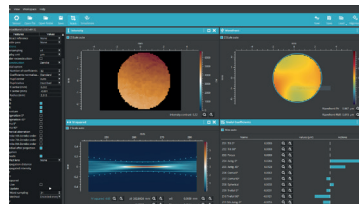
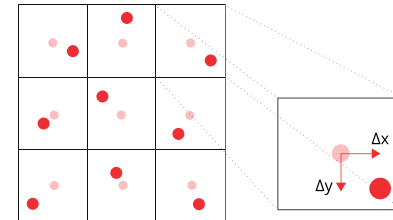

Intensity profile, wavefront,
Zernike coefficient and M-squared
– clockwise from top left – in Waveview 4.3

HASO LIFT SERIES

LINEARIZED FOCAL PLANE TECHNIQUE, A 16-FOLD INCREASE IN SPATIAL RESOLUTION

Linearized Focal Plane Technique was developed in the early 2010s and presented in a seminal paper by Serge Meimon et al. The central idea is to analyze the focal point intensity map created by each microlens and use phase retrieval techniques to measure the wavefront at the scale of each microlens.

This high-resolution option is a spectacular enhancement for a majority of wavefront metrology applications and has already convinced dozens of clients around the world to adopt it.

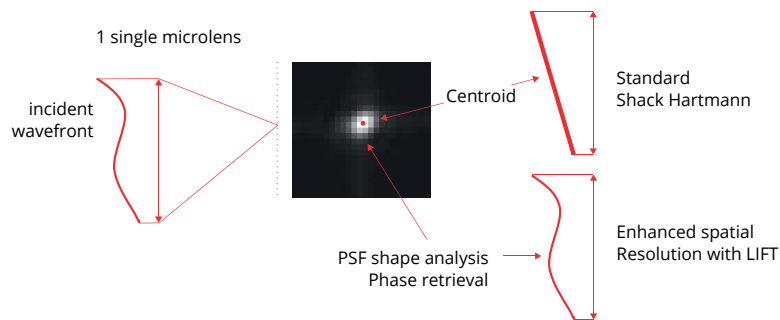

REACHING INTERFEROMETRY STANDARDS IN RESOLUTION

Shack-Hartmann is a very robust and precise technology with a long diverse track record in optical metrology. Yet, its limitations in resolution when compared to interferometry were a clear obstacle to its applications in large and flat optics manufacturing.

The LIFT technology developed by Imagine Optic in 2021 is a game-changer.

LIFT wavefront sensing is now poised to disrupt optical metrology by bringing together the best of two worlds:

- + simplicity, robustness and precision from its Shack-Hartmann core
- + single-frame, high-resolution analysis from the LIFT algorithms.

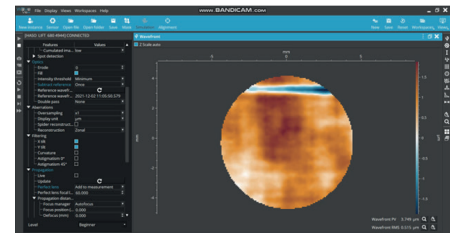

HASO STANDS FOR

- + Achromaticity
- + Standard accuracy $\lambda/100$
- + Insensitivity to vibrations
- + Adaptive optics compatibility
- + Waveview4 metrology software
- + SDK in C++ / Labview / Python

OEC COMPATIBLE

HASO LIFT wavefront sensors were designed with a clear commitment to metrology, both as standalone instruments and as the core of the Optical Engineer Companion optical metrology system.

LAMBDA/100 RMS

Repeatability is key to high-end optical applications. This is why all our HASO4 and HASO LIFT wavefront sensors are calibrated to the highest standard.

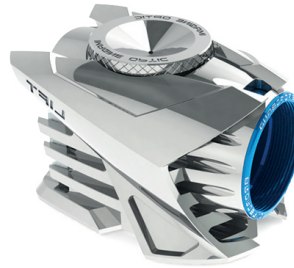

HASO LIFT 272
The Polymath
400-800 nm
272x200 phase points



HASO LIFT 680
The Best-in-Class
400-800 nm
680x504 phase points



HASO LIFT SWIR 160
The Prodigy
1050-1700 nm
160 x 128 phase points

HASO4 SERIES

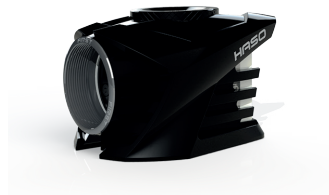

HASO4 First | On-demand wavelength
400-800 nm

Best for:

- + Adaptive Optics applications for microscopy or Ultra-High Intensity Laser
- + OEM applications in optical metrology and beam diagnostics

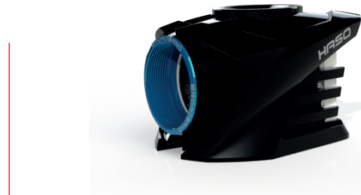

HASO4 Broadband | The Workhorse
350-1100 nm

Best for:

- + Labs and teams with strong expectations for versatility
- + Alignment of complex optical systems
- + Metrology, microscopy, laser diagnostics

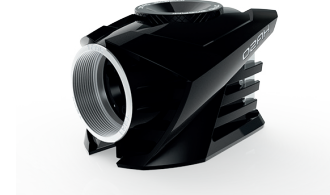

HASO4 FAST | The Khz
400-800 nm

Best for:

- + Adaptive optics for atmospheric turbulence
- + Laser beam optimization
- + Freespace communications

5 key advantages

of Shack-Hartmann wavefront sensing

- #1** Direct measurement of wavefront derivatives
- #2** No correlation between wavefront measurement and intensity profile
- #3** Changes in the wavelength will not affect the calculated wavefront
- #4** Insensitive to vibrations because Shack-Hartmann does not rely on interference
- #5** 1-frame reference



HASO4 126 | The Big Guy
400-750 nm • 13.78x10.21 nm pupil

Best for :

- + Freeform optics & metasurface characterization
- + Parabolic mirror characterization
- + Applications involving high spacial frequency aberrations



HASO4 126 Broadband | The Hulk
350-1100 nm • 13.78x10.21 nm pupil



HASO4 1550 | The Free-Spacer
1550 nm • 4.5 x 3.6 mm pupil

Best for :

- + Telecommunications
- + IR and SWIR Lasers
- + LIDAR application
- + Fiber coupling
- + Aligning and characterizing any optical systems at 1550 nm : afocal, collimator, lens, zoom



HASO SWIR | The InGaAs
900-1700 nm • 9.30 x 7.44 mm pupil

Best for :

- + Optical metrology
- + Adaptive optics applications such as long-range communication
- + Optimizing the alignment of complex systems
- + Light-source characterization/aberrations

HASO STANDS FOR

- + Achromaticity
- + Standard accuracy $\lambda/100$
- + Insensitivity to vibrations
- + Adaptive optics compatibility
- + Waveview4 metrology software
- + SDK in C++ / Labview / Python



OECD COMPATIBLE

HASO4 wavefront sensors were designed with a clear commitment to metrology, both as standalone instruments and as the core of the Optical Engineer Companion optical metrology system.

LAMBDA/100 RMS

Repeatability is key to high-end optical applications. This is why all our HASO4 and HASO LIFT wavefront sensors are calibrated to the highest standard.

R-FLEX LA SYSTEMS

The R-FLEX LA and R-FLEX LA SWIR extend the capabilities of R-FLEX2 optical metrology systems. These configurations of the Optical Engineer Companion are specifically adapted for the metrology of large optics and optical surfaces such as filters, dichroic beam splitters, head-up displays, eyewear, optical windows, flat mirrors, polarization scramblers.



SWIR

- R-FLEX LA SWIR 30 mm
- R-FLEX LA SWIR 75 mm
- R-FLEX LA SWIR 100 mm
- R-FLEX LA SWIR 150 mm

Custom dimensions
on demand



VIS-NIR

- R-FLEX LA 30 mm
- R-FLEX LA 75 mm
- R-FLEX LA 100 mm
- R-FLEX LA 150 mm

Custom dimensions
on demand

OHIO
OEC COMPATIBLE

R-FLEX² SYSTEMS

R-FLEX2 is the second generation of our versatile optical metrology system that instantly combines any of our HASO4 and HASO LIFT wavefront sensors with a collimator and a light source.

R-FLEX2 has proved a time-saver and a game-changer in the alignment of complex optical systems such as telescopes, notably due to its capabilities and versatility in measuring on- and off-axis 3D MTF.

The R-FLEX2 systems come in 2 flavors:

- + R-FLEX2 “regular” for the VIS-NIR in the 400 – 1100 nm range.
- + R-FLEX2 SWIR in the 1000-1700 nm range.



R-FLEX2 SWIR

Compatible wavefront sensors
1000-1700 nm

HASO4 1550

HASO SWIR

HASO SWIR LIFT 160

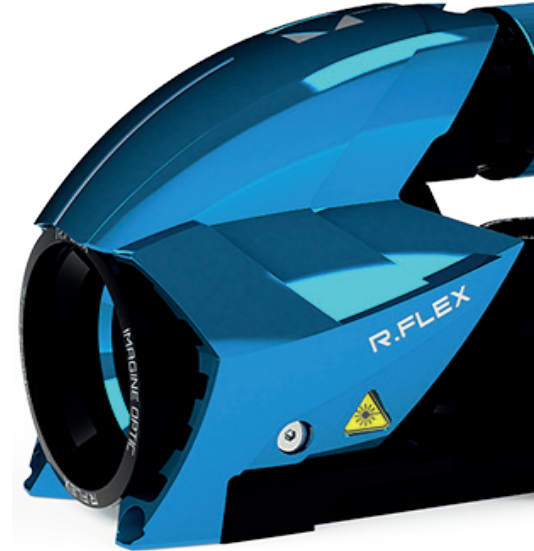

R-FLEX2

Compatible wavefront sensors
400-1100 nm

HASO LIFT series

HASO LIFT 680

HASO LIFT 272

HASO4 series

HASO4 First

HASO4 FAST

HASO4 Broadband

HASO4 126

HASO4 126 Broadband

 **OEC COMPATIBLE**

THE OPTICAL ENGINEER COMPANION

imagine  optic



R-FLEX²

Wavefront sensing metrology platform

“

To me, -the top 3 advantages of the OEC are, first you have instant access to the visualization, there is no post-processing. Second I would put the fact that you can use it outside the lab, there is no need for an optical table. And last but certainly not least, you can build your own instrument and adapt it to your needs as they evolve.

Adam A.,
Optical Engineer



R-FLEX LA

Characterization in reflection or transmission for optics 30-150 mm

Metrology on-the-go with super-resolution and unparalleled flexibility

The Optical Engineer Companion is an optical metrology system comprising compatible and complementary optical hardware, software and accessories.

The Companion modularity and clever design enable snap reconfigurations for switching between setups and applications, while its accuracy and super-resolution make it the perfect omnitool for optical metrology on-the-go.

HASO

Wavefront sensors from 400 to 1700 nm

HASO **EDGE** SERIES

Special Wavefront Sensors & Optical Benches



Imagine Optic's trademark for over 20 years has been to develop and deliver made-to-measure solutions to scientific and industrial conundrums. Across dozens of wavefront sensors that were born to meet specific needs we have carefully selected the EDGE series. They are essentially clones that can be quickly produced and delivered to meet specific requirements. Hereunder are three examples of uncommon yet popular EDGE configurations.

Other EDGE wavefront sensors are available to meet specific requirements such as UltraViolet, I/1000 RMS repeatability, Multispectral...

FAST & SWIR

940-1700 nm
3.26 mm x 3.26 mm
1.9 KHz



VACUUM COMPATIBLE

10E-6 mbar with no degazing
40x32 microlenses
650-950 nm





VERY LOW FLUX

10nm RMS repeatability @ 10000ph/s
26x18 microlenses
visible range





Imagine-optic 
@imagineoptic 
@wavefrontrunners 

Airbus, Corning, ESA, Essilor, NASA and hundreds of leading tech companies and research institutions have trusted us over these 25 years to assess, align, and optimize optical systems, from optical lasers, telescopes to smartphones, AR/VR headsets to autonomous vehicles.

Imagine Optic is a world leader in wavefront analysis and adaptive optics. Since 1996, we have delivered 3,000+ wavefront sensors, metrology systems and deformable mirrors to major research institutions and technology companies.

CONTACT US

Imagine Optic Headquarters
18, rue Charles de Gaulle
91400 ORSAY · France
Phone +33 (0)1 64 86 15 60
Fax +33 (0)1 64 86 15 61
sales@imagine-optic.com
www.imagine-optic.com